



2024 Evaluation Form

ASR2011

Inseam Range: 22" - 35"

- Max inseam may not allow for full leg extension.

Pre-teen and adult riders can experience the joy of riding with this semi-recumbent tricycle. The ASR2011 features a low step-through height of 15" which allows for easier transfers, as well as a low seat base for added stability. Thanks to its adjustability, this bike for life will provide riders with the fun and therapeutic benefits of riding a bike for many years to come.



| ASR2011 MODEL SPECIFICATIONS | |
|------------------------------|-----|
| Rider Age | 10+ |
| Max Load (lbs) | 225 |
| Bike Weight (lbs) | 83 |
| Frame Height | 39" |
| Total Length | 85" |
| Bike Width | 35" |
| Step-Through Height | 15" |

Measurements Include Rear Steering Handle and High Back Seating

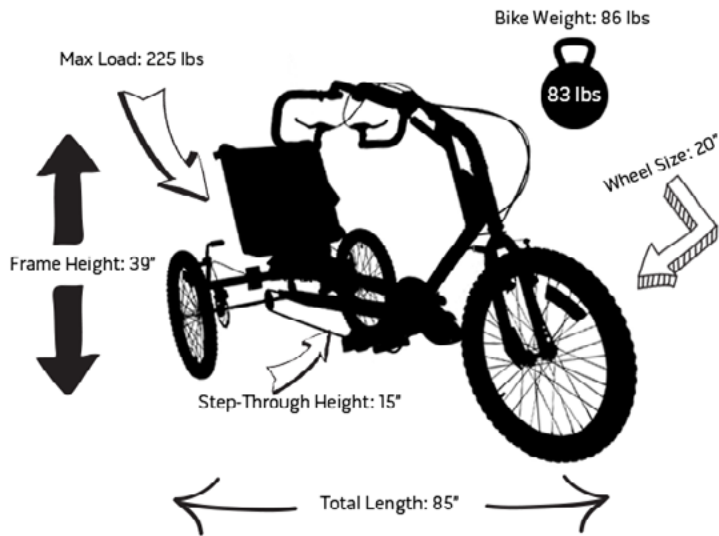

Tips For Choosing an Adaptive Bike

1. Measure Inseam

The measurement we use to ensure each rider gets the correct size of adaptive bicycle is called an inseam. To find an inseam, measure the distance between the bottom of the rider's heel to the top of the rider's inner thigh. Make sure the rider's inseam measurement matches the inseam range for the adaptive bicycle.

2. Know Your Accessories

We offer many different accessories to help people of all abilities experience freedom. Make sure to look through all of our available accessories to make sure the adaptive bike will work for the rider. More information on all of our accessories is available at: www.freedomconcepts.com/product-lines/adaptive-bikes/accessories/

3. We Do Custom

If none of our current models of adaptive bicycles work for you, we are able to custom build a bicycle that will. Please contact us at 1-800-661-9915 for more information.

RIDER INFORMATION

Rider's Name: _____ Male Female Height: _____ Inches _____ cm





Date of Birth: _____ Weight: _____ Lbs _____ Kgs











Inseam: _____





Diagnosis: _____

ASR2011



- Inseam Range: 22" - 35" - Max inseam may not allow for full leg extension

| MODEL | | FRAME ADD-ONS (Optional) | |
|--|--|--|--|
|  |  |  |  |
| The standard ASR2011 frame accommodates an inseam range of 22"-35". Max inseam may not allow for full leg extension. | The ASR2011 HD frame accommodates a Max Load of 430lbs and an inseam range of 27"-38". This frame is 4" longer. *Please note this package includes HD Wheels *Not compatible with Short Frame. | The ASR2011 Short Frame shortens the length of the bike by 5" making this frame ideal for those with little storage space. | The ASR2011 Narrow Frame is ideal for indoor use as it fits through standard doorways with a width of 31". |
| <input type="checkbox"/> ASR2011 (ASR2011) | <input type="checkbox"/> ASR2011 HD (ASR2011-HD) | Short Frame (SHORTFRAME) | Narrow Frame (NARROW FRAME) *Shortens 4" from width of frame |

| FRAME COLORS- Select one | |
|--|--|
| Standard Options | Additional Options |
|     |        |
| Candy Blue (CANDY BLUE) (STD) Hot Rod Purple (HOT ROD PURPLE) (STD) Electric Green (GREEN) (STD) Cherry Red (RED) (STD) | Arctic Teal (TEAL) Blaze Orange (ORANGE) Radiant Pink (PINK) Chrome (CHROME) Midnight (BLACK) Snow (WHITE) Fossil (FOSSIL) |
| Custom Color (CUSTOM COLOR) Please indicate custom color note here: | Color combination (COLORCOMBO) Please indicate primary frame color: Please indicate secondary accent color: |

| DECAL OPTIONS - Select one | NAMEPLATE (Optional) | BELL & SQUEAKY HORN (Select one Bell & one Horn) | |
|--|--|---|---|
| Racer (STD) (6401432)  | Custom Nameplate Nameplate (NAMEPLATE SP) Notes:  | Bells (STD) | Squeaky Horns (Optional) (STD) |
| Hibiscus (STD) (6401443)  | | Red (5015014) Blue (5015011) Purple (5015013) Gold (5015012) Black (5015010) | Dog (5015063) Frog (5015065) Cat (5015061) Parrot (5015070) Orca (5015067) |
| Black & White (STD) (6401420)  | | Dino (5015062) Penguin (5015068) Unicorn (5015071) Tiger (5015069) Shark (5015072) | Turtle (5015074) Giraffe (5015075) |

| TIRE SELECTION - Select one * HD Package includes HD Wheels | | |
|--|--|---|
|  |  |  |
| Smooth Solid Tires (STD) (SMOOTH SOLID TIRES) Ideal for indoor and outdoor use, with limited speeds and/or with caregiver present Wheel Add-On: Heavy Duty Rim (HD Wheels) | Knobby Pneumatic (2112352) Ideal for more independent riders, wanting to ride outdoors or on uneven surfaces. Wheel Add-On: Heavy Duty Rim (HD Wheels) | Smooth Pneumatic (2112351) Ideal for more independent riders, wanting to ride at faster speeds Wheel Add-On: Heavy Duty Rim (HD Wheels) |

| HANDLEBAR OPTIONS - Select one | | |
|---|---|--|
|  |  |  |
| Hoop Handlebars (STD) (2111001) | Enclosed Hoop Handlebars (2111003) | Wide Handlebars (2111007) |

| T-BAR SUPPORT HANDLE |
|---|
|  |
| T-Bar Support Handle (2111469) |

| STEERING OPTIONS - Select Setup | |
|---|---|
| Unlocked Steering (STEERUNLOCKED) <i>This option allows the rider to control the steering.</i> | Locked Steering (STEERLOCKED) <i>This option takes steering control away from the rider so the caregiver can have full control of the bike with the Rear-Steering Handle.</i> |
| *Please note you can change the steering from unlocked to locked by using the Freedom Concepts multi-tool that comes with every bike. | |

| REAR STEERING |
|---|
|  |
| Rear Steering Handle (REAR STEER) |

| REAR STEERING ADD-ONS | |
|---|---|
|  |  |
| Pushbar Steering (2125006) *Requires Rear Steering Handle | Hoop Handlebar (2125005) *Requires Rear Steering Handle |

| PROPULSION - Please fill out one column | | | |
|--|---|--|---|
| Direct Drive (STD) (DIRECT DRIVE) <i>When the bike is moving, the pedals are moving.</i> | Free Wheel (FREE WHEEL) <i>Allows legs to rest while the bike coasts forward.</i> | On/Off Pin Reciprocator (ON-OFF) <i>Alternate from Free Wheel mode or Direct Drive by engaging the On/Off Pin Reciprocator.</i> | Nexus 8 Speed Drive (2012091) 5-Speed Coaster Brake with Reverse (2060016) |
| Pedal Power Extra Easy (EXTRA_EASY) Easy (EASY) Average (AVERAGE) Challenging (CHALLENGING) | Pedal Power Average (AVERAGE) Challenging (CHALLENGING) | Pedal Power Easy (EASY) Average (AVERAGE)  | Shifter Location: Right (SHIFTHB) Handlebar Rear Steering Handle (SHIFTRS) T-Bar (SHIFTTB) |

Seating System

Please Fill Out Either The Child Set Up or The Adult Set Up

Please note that all seat bases come with a seat belt and all high-back back rests come with a chest strap

| | |
|------------------------|---------------------------------|
| Child Seat | 12.5" width, 12.5" depth |
| Child High-Back | 13" width, 18" height |
| Adult Seat | 16.75" width, 14" depth |
| Adult High-Back | 17" width, 18" height |



The 2" raised pommel keeps riders further back in their seats while helping with stability and promotes leg abduction.





A narrow seat aids in clearance and in pass-through. The nose of the seat is slightly narrower to aid with pedaling.



The standard seat will fit and function for most riders.

| ADULT SET UP (Recommended) | |
|--|--------------|
| Seat Base | |
| Adult Seat (2114061) | (STD) |
| Adult Narrow Seat (6114017) | |
| Adult Pommel Seat (6114018) | |
| Adult Narrow Pommel Seat (6114020) | |
| Four-Point Neoprene Hip Stabilizer Belt (2125274) *OPTIONAL | |
| Back Rest | |
| Adult High Back (2114090) | (STD) |

SEATING ACCESSORIES (Optional)

| | | |
|--|---|---|
| Neoprene Chest Harness  | Laterals (<i>Width and height adjustable, comes with an adjustable track system</i>)  | Flip-Up Abductor  |
| Medium (2114077) Large (2114078) Extra Large (2114079) | Pair of Standard Small Laterals <i>Small Laterals Chest Width: 8½" - 11¼"</i> (2114070) Pair of Standard Large Laterals <i>Large Laterals Chest Width: 12"-15"</i> (2114072) Chest Width: _____ Seat-to-Armpit: _____ Laterals Add-On: Narrow Laterals (2125033) <i>*Shifts chest width range 2" narrower</i> | Flip-Up Abductor (2020205) <i>This flip-up abductor assists with leg/knee separation during pedaling and is mounted securely to the underside of the seat.</i> |

HEADRESTS (Optional)



| | | |
|--|---|---|
|  |  |  |
| Adjustable Backrest Extension (HEADREST) <i>The adjustable headrest extends the seat backing height an additional 7" and can be removed for ease of transport.</i> | Adjustable Headrest with Occiput Support Cushion (HEADREST PLUS) <i>The adjustable headrest with an occiput support cushion provides additional neck support for the rider. The cushion comes with velcro and can be removed or adjusted as required.</i> | Head and Neck Support <p style="text-align: center;">*Please call 1-800-661-9915 for sizing and part number. In some cases we are able to adapt our seatback to accommodate common wheelchair headrests.</p> |

PEDAL OPTIONS - Select one

| | | | |
|--|---|--|---|
|  |  |  |  |
| <i>Mountain Pedals are recommended for riders that have more control and high tone muscle control.</i> | <i>The Neoprene adjustable footplate is a quick and easy way to maintain proper positioning and pedal pressure. Recommended for children with low muscle tone.</i> | <i>Molded ABS Footplates are designed to provide precise positioning for children with more spasticity. They also help with leg alignment and knee flexion.</i> | <i>Molded ABS Footplates with Ratchet Straps helps to secure the riders foot in a specific position. Recommended for children with plantar flexion.</i> |
| Mountain Pedals with Toe Cage (STD) (2112081) | Neoprene Adjustable SML (2012031) *4" x 7" MED (2012032) *4½" x 10" *LRG (2012033) *5" x 11½" *XL (2012034) *5½" x 12" | Molded ABS SML (2012042) *3" x 7" MED (2012043) *3" x 10¾" *LRG (2012044) *3½" x 11½" *XL (2012045) *4" x 13" | Molded ABS with Ratcheting Straps SML (2012052) *3" x 7" MED (2012053) *3" x 10¾" *LRG (2012054) *3½" x 11½" *XL (2012056) *4" x 13" |

***Please note: Front Pulley String is required for LRG and XL footplates**

PEDAL ADD-ONS - (Optional)

| | |
|--|--|
|  |  |
| 1/4 Inch Footplate Spacers (2412050) Please add how many spacers are needed below. (Maximum 8 per side) _____ left + _____ right = _____ total | Pulley String <i>Front pulley assists with plantar flexion.</i> Front (2115022) |

CHAINGUARD - Select one

| | |
|--|--|
|  |  |
| Heavy Duty Steel Chainguard (STD) (STD CHAINGUARD) | ABS Enclosed (ABS ENCLOSED) *Recommended for multi-user environments. |

BRAKE OPTIONS AND POSITIONS

Select Front Brake Position (Included)

*Please select one option

- Left Handlebar (2113412) *Not Available with High Rise Handlebars
- Right Handlebar (2113411) *Not Available with High Rise Handlebars
- Rear Steering Handlebar (2113413) *Rear Steering Handle Required
- T-Bar (2113414) *T-Bar Support Handle Required

Select Rear Brake Position (Included)

*Please select one option - must differ from front brake position

- Left Handlebar (2113422) *Not available with High Rise Handlebars
- Right Handlebar (2113421) *Not available with High Rise Handlebars
- Rear Steering Handlebar (2113423) *Rear Steering Handle Required
- T-Bar (2113424) *T-Bar Support Handle Required

BRAKE ADD-ON (Optional)

Adjustable Drag Brake (2013215) *T-Bar Support Handle or Rear Steer Required

CRANK ARMS - Select one

- 3" Alloy Crank (N/C) (5012252)
- 4" Alloy Crank (N/C) (5012254)
- 5" Alloy Crank (STD) (5012255) *Recommended

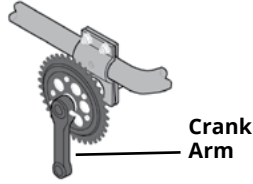

Crank Arm Length Shortener

*reduces length by 1/2" (optional)

- Left Side (2012049)
- Right Side (2012050)
- Both Sides (2012047)

FRONT FORK - Select one



Rigid Chrome Fork (STD) (5011021)



Suspension Fork (2411552)

ACCESSORIES - (Optional)



Velcro Hand-Eye Coordination Gloves

- XS (6315031) 5 1/2" height x 1 3/4" wrist
- SML (6315033) 6" height x 2" wrist
- MED (6315034) 7" height x 2 1/4" wrist
- LRG (6315035) 8" height x 3 3/4" wrist



Indoor Stationary Trainer (2022310)



Leg Braces

*Only available with molded footplates.
*Requires Rear Pulley.

- Left Side Only (LEG BRACE L)
- Right Side Only (LEG BRACE R)
- Pair (LEG BRACE PAIR)

Inseam: _____
Calf Circumference: _____
Measurement with AFO's



Rear Platform (REAR PLATFORM)



Removable Canopy (6515011)

*Requires T-Bar or Rear Steer

ACCESSORIES - (Optional)



Spoke Covers (3) (2112341)



Adjustable Tablet/Phone Holder

- Tablet (5025070)
- Phone (5025080)



Cane/Crutch Holder (2125060)







Padded Adduction Strap (6320060)



Electric Assist Motor (2125361)

*Requires Rear Platform
*Requires Suspension Fork

ACCESSORIES - (Optional)

| | | | | |
|---|--|---|---|---|
|  |  |  |  |  |
| Communication Tray (2125281) | Simulated Sheepskin Cover Child Seat (6114070) Adult Seat (6114080) | Mirror (5015040) | Tool Pouch (6300022) | Bike Cover (6315604) |

CUSTOMER INFORMATION

Dealer/Vendor: _____
Contact Person: _____
Address: _____
City: _____ Prov./State: _____
Postal/Zip Code: _____ Ordered by: _____
Phone: _____ Fax: _____
Email: _____

ORDER INFORMATION

Purchase Order: _____
Order Date: _____ Quote Date: _____
FCI Representative: _____
Payment Terms: _____
CREDIT CARD (CHECK ONE) Visa MasterCard Exp. Date: _____
Card Number: _____
Name On Card: _____
Signature: _____

SHIPPING INSTRUCTIONS

Name: _____
Address: _____
City: _____
Province/State: _____
Postal/Zip Code: _____ Phone: _____
Federal ID/SS#: _____

PRIVACY POLICY

Freedom Concepts Inc. collects, uses and discloses personal information of the Customer and/or Rider to properly assemble and manufacture the mobility device and may contact the Rider's therapist for additional personal information to assist with this process. The collection, use and disclosure of the personal information of the Customer and/or the Rider is governed by any consent which may, from time to time, be provided, and by the Freedom Concepts Inc. Privacy Policy which is available on our website www.freedomconcepts.com or by contacting our office. By signing below, you hereby warrant that you have the authority to bind the Rider and hereby authorize the collection, use, and disclosure of personal information as herein provided and in accordance with the Freedom Concepts Inc. Privacy Policy.

TERMS AND CONDITIONS

Prices are subject to change without notice. Prepaid or net 30 days O.A.C. All taxes extra. Freight extra. Manufacturer reserves the right to change prices, colors, features, dates, locations and products without notice. Residential delivery charge may apply. Duty and brokerage included where applicable.

CUSTOMER SIGNATURE

PHOTO RELEASE

I hereby give permission to Freedom Concepts Inc. to use photographs of me or my child at their discretion. YES NO

I would like to receive regular updates. SNAIL MAIL EMAIL NO

SIGNATURE OF RIDER/PARENT

NOTES: